

# Operating Manual

## BROSA Measuring Block Type 0230

*English translation of German original operating manual*

*Version: 01/2024*

## Contents

1	General information .....	3
1.1	Safety instructions – Explanation of symbols:.....	3
2	Description of the BROSA measuring block .....	4
2.1	Structure and functionality .....	4
2.2	Information on explosion protection .....	6
2.3	Indication of measuring direction .....	6
3	Advice on the safe handling of BROSA force measuring sensors .....	6
3.1	Handling.....	7
3.2	Installation and commissioning .....	7
3.2.1	General information .....	7
3.2.2	Additional information for operation in areas subject to explosion hazards ..	8
3.2.2.1	Intrinsically safe sensors .....	9
3.3	Operation and maintenance.....	10
3.3.1	Operation .....	10
3.3.2	Maintenance .....	11
3.4	Disassembly .....	11
3.5	Disposal.....	12

---

## 1 General information

Read the operating instructions and the product-specific documents carefully before commissioning the sensor.

Make sure that the sensor is fully suitable for the applications in question.

Improper use or any use other than intended may result in a malfunction of the sensor or undesirable effects in your application. For this reason, installation, electrical connection, commissioning and maintenance of the sensor may only be carried out by trained personnel authorized by the plant operator.

We also expressly point out that any liability is excluded if instructions in this documentation are disregarded.

The specified properties apply exclusively in the unchanged delivery condition. Applicable standards and guidelines must be observed, especially when recoating.

Current certificates can be downloaded from the BROSA GmbH website.

Only the German version of this operating manual represents the original document.

### 1.1 Safety instructions – Explanation of symbols:



**WARNING!** This symbol indicates dangers that can lead to personal injury and property damage!

---

## 2 Description of the BROSA measuring block

### 2.1 Structure and functionality

The BROSA measuring block type 0230 is used when two forces are introduced at the measuring point from different directions, but only the (resulting) component of a direction is to be measured. This force direction to be evaluated may be different from the two directions of force application. Figure 1 shows the typical construction:

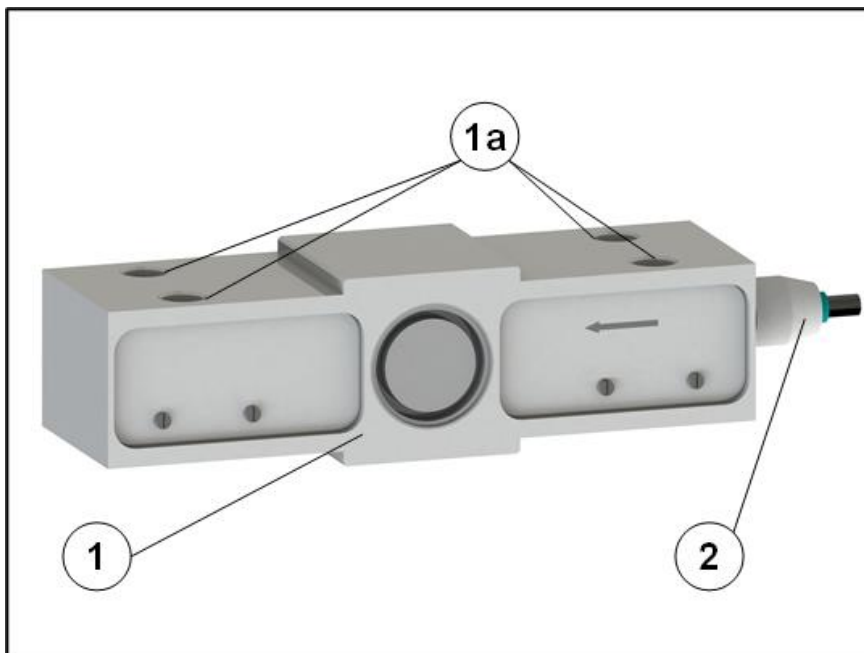

Figure 1: Structure of the measuring block

The measuring block consists of a block-shaped measuring body (1) which receives the load to be measured and which exhibits features for mounting (1a). If the measuring block is supplied with integrated evaluation electronics, it is - if it is not placed in the measuring body - in a connection board firmly connected to the measuring body (not shown in the picture), on which - if they are not placed directly on the measuring body - the elements necessary for the electrical connection (plug or cable, 2) are mounted. Measuring body and, if necessary, connection board are made of stainless steel.

The use below the water surface is generally possible after testing and approval by BROSA, special requirements are the used materials and surface coatings, the tightness and the electrical connections.

In addition, there is the possibility that the water pressure impacts the measurement result.

Figure 2 shows the typical installation conditions:

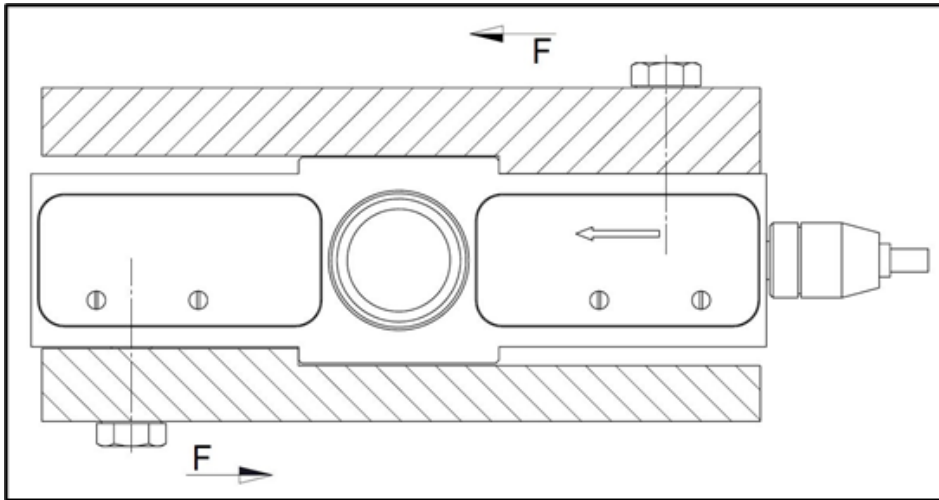

Figure 2: Installation conditions

The measuring block (1) is mounted on both ends on the console surfaces of the mounting structure (2); a screw connection is usual for fastening. The force  $F$  transmitted from the connection is applied in a plane on the measuring block, but not in a line; it is transmitted by the evaluation of the resulting deformation of the measuring body on the measurement electronics and outputted as an electric signal.

Designs are optionally available only for tension, only for pressure or for tension/pressure, with two measuring systems, combined with either the output signals on separate connectors/cables or in one connector/cable. More information can be found in the technical data sheets, which may be obtained free of charge from BROSA.



**WARNING!** An insufficiently rigid surrounding construction, inadequate force transmission or inadequate surface condition of the force-carrying surfaces affect the measurement result!

---

## 2.2 Information on explosion protection

The type 0230 measuring block is optionally available in an intrinsically safe design for use in potentially explosive atmospheres. Actual certificates can be downloaded on BROSA Homepage.



Use of intrinsically safe measuring blocks in zone 0 is not allowed. Current certificates can be downloaded from the BROSA GmbH website.

## 2.3 Indication of measuring direction

The measuring direction is indicated by an arrow icon (Figure 3, 2). The arrow always indicates - regardless of design - the direction of the tension.

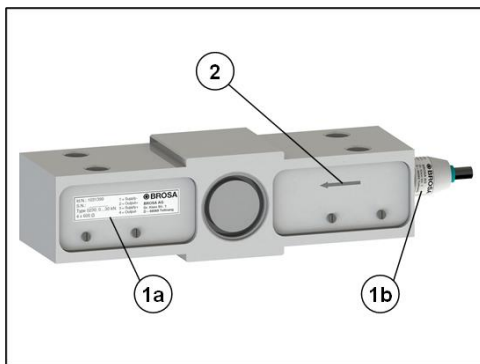

Figure 3: Measuring direction

## 3 Advice on the safe handling of BROSA force measuring sensors



**WARNING!** Non-compliance with the following instructions can lead to sensor damage and/or impairment of measurement results. The analysis of an erroneous measurement can result in personal injury or material damage.



**WARNING!** Despite their sturdy design, BROSA force measuring sensors may not be used for any other than the intended purpose (see. Section 1.1). With improper use,

---

dangers to life and limb of the user or third parties and/or impairment of the device in which the force measuring sensor is implemented or other material assets can be caused.

### 3.1 Handling

 **WARNING!** BROSA sensors contain high-quality measurement electronics. Make sure they are handled carefully.

- BROSA force measuring sensors are delivered in transport-safe packaging. We recommend that you remove the sensors from the package immediately prior to installation.
- The mass of the force measuring sensor is to be observed when selecting appropriate handling equipment and/or lifting gear.
- BROSA force measuring sensors must be secured against falling. Do not throw sensors!
- Use as a tool (e.g., impact, slotting or lever tool) is not permitted; it can cause damage to the sensor and thus falsify the measurement results.

### 3.2 Installation and commissioning

#### 3.2.1 General information

We recommend taking the following actions in the given order using the “four-eye principle”.

- a) Checking the sensor-measuring point assignment: It must be ensured that the sensor to be installed is designed for use at the intended measuring point. For this purpose, check information on the technical datasheet and the nameplate, in particular the item or the identification number and the measuring range, against the data of the measuring point.

 **WARNING!** A sensor not designed for the particular measuring point must not be installed.

- b) Inspection of the sensor for intactness and function: It must be ensured that the sensor to be incorporated is free of damage of any kind.



WARNING! A damaged sensor must not be installed!

- c) Installation of the sensor in the measuring point:  
The force measuring sensor is to be installed according to the offer drawing and is to be aligned on the intended contact surface.



WARNING! The force measuring sensor must not be driven in or aligned using impact tools!

After alignment, which may be necessary depending on the sensor type, the force measuring sensor must be secured against movement and rotation using the elements provided for this purpose. Attention must be paid to the correct alignment of the force measuring sensor to the intended measuring direction (see direction marks).



WARNING! A misaligned sensor leads to erroneous measurement results!

- d) Establishment of electrical connection: The elements on the sensor for the electrical connection are to be connected to the power supply, the earth connection if necessary, and the evaluation system of the device. In doing so, the information given on the nameplate for plug or cable assignment and, if applicable the installation guidelines of the cable, are to be observed.



WARNING! An incorrect or incomplete electrical connection impairs or prevents measurement.

- e) Functional check: After completed mechanical (see c) and electric (see d) installation, load on the sensor is to be applied over the entire measuring range; the output measurement signals are to be subjected to a plausibility check.



WARNING! If due to unusual events (e.g., deformation or unusual noise), measurement results are considered implausible or there is suspicion that the sensor is malfunctioning for any other reason, it must not be put into operation.

### 3.2.2 Additional information for operation in areas subject to explosion hazards



Only those sensors with the corresponding labels are approved for use in areas subject to explosion hazards.

If the open cable end is connected inside an area subject to explosion hazards, the connection must be inside a terminal box/switching cabinet certified in accordance with the ATEX-directive. If it is connected outside an area subject to explosion hazards, it must be in line with the general requirements for electrical equipment.

When using intrinsically safe (Ex-i) sensors, the use of an Ex-i isolator is mandatory to limit the energy supplied to the hazardous area and to provide galvanic isolation from all other non-intrinsically safe circuits.

### 3.2.2.1 Intrinsically safe sensors

Sensors using ExDANGmicro2W\*\*\* amplifiers are to be installed according to the following specifications:

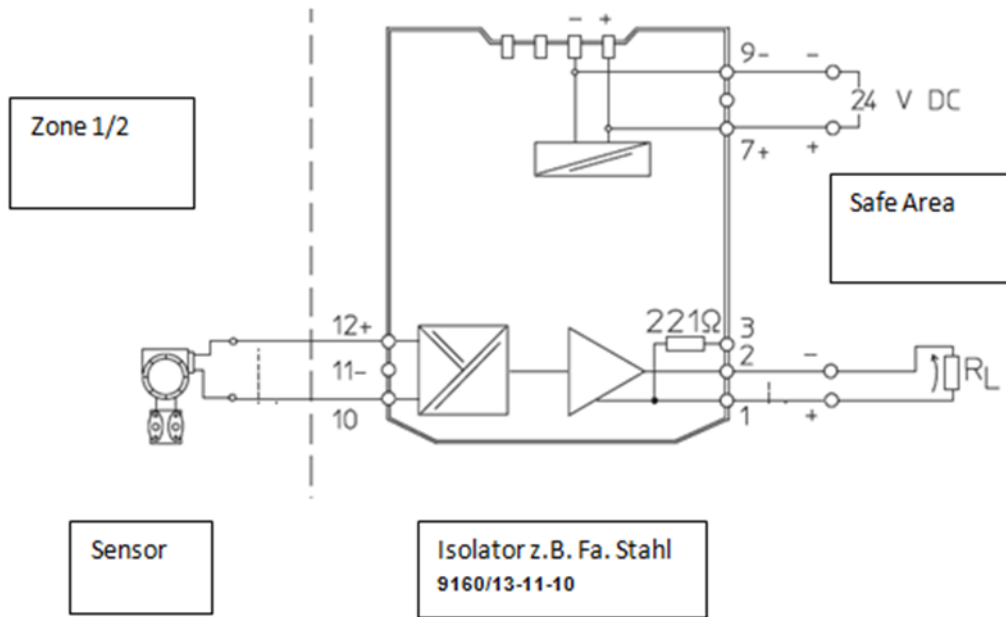

Figure 6: Connection example Ex i sensor with Ex DANGmirco2W\*\*\* amplifier

The supply and the measuring signal are fed into the hazardous area via an isolation amplifier. Isolation amplifiers from other manufacturers can also be used if they meet the safety-related limit values.

During installation, the distinction with regard to the insulation strength of the strain gauge resistance bridge against the sensor spring body must be observed. The amplifier type ExDANGmicro2W\_A\*\* is to be regarded as separate from the spring body. The

---

amplifier type ExDANGmicro2W\_B\*\* is to be regarded as connected to the spring body in the event of a fault.

The routing of the connection cable for amplifier type ExDANGmicro2W\_\*B2 and type ExDANGmicro2W\_\*B4 requires protection against damage and tensile stress, ensured by a suitable device.

The complete list of possible amplifier configurations can be found in the certificate.

### 3.3 Operation and maintenance

#### 3.3.1 Operation

BROSA force measuring sensors operate automatically; attaching tools is not required for operation. Direct manual intervention by the operator is not necessary; there are therefore no requirements for the operator to wear protective equipment during operation. However, the relevant requirements for the device in which the force measuring sensor is implemented must be observed.

BROSA force measuring sensors emit neither airborne acoustic noise nor electromagnetic radiation.

Operation of BROSA force measuring sensors is permitted only within the parameters and properties given in the technical datasheets and on the nameplate.

These are, among others:

- Measuring range
- Temperature range
- Permissible supply voltage
- Electrical protection class
- Material

It must be ensured that no parasitic influences such as forces transverse to the measuring direction are transmitted via the force measuring sensor.

Inductive or capacitive coupling with the connection cable(s) of the sensor can distort the measurement result and must be avoided. Some examples of these kinds of couplings

---

can be caused e.g., by unfavourable cable routing (parallel power lines, frequency converters, transformers, motors, incorrect grounding/shielding and the like).

When performing electric welding in the vicinity of the sensor, all connections must be disconnected and isolated. It must be ensured that no welding current is flowing through the sensor.

 **WARNING!** Operation outside the specified parameters or contrary to existing properties or improper use can damage the sensor and cause it to fail or lead to faulty measuring results. If the sensor is overloaded, this can lead to the whole machine being equally overloaded and possibly endangering its stability.

### 3.3.2 Maintenance

In its capacity as a sensor, BROSA force measuring sensors are maintenance-free. As load-transmitting elements, however, they are subject to mechanical stress, requiring regular inspections of the fault-free state of each force measuring sensor. The intervals between inspections depend on the intensity of use and must be determined by the end-user. Additional lubrication holes are not necessary for the sensor to function, but are used to lubricate secondary components, so the end-user is responsible for the lubrication cycles.

An inspection includes the following points:

- Visual inspection for damage to the measuring body and wiring as well as contamination.
- Function test/plausibility check

The causes of existing errors are to be identified and remedied. If the test indicates an improper sensor state, it must be taken out of operation. If a malfunction or damage is detected on the sensor, it must be sent to the manufacturer's factory for diagnosis and, if necessary, repaired.

 **WARNING!** The sensor may only be repaired at the factory. Intervention (e.g., opening, mechanical processing and the like) done by parties other than the manufacturer means the safe operation of the sensor is no longer ensured and voids the warranty.

## 3.4 Disassembly

We recommend performing the following actions in the order given.

---

- 
- a) Establishment of a load-free state at the measuring point: The force measuring sensor is to be unloaded before removal.

 **WARNING!** Removal of a force measuring sensor under load poses serious dangers to the life and limb of bystanders and can cause major damage. This is therefore not permitted.

- b) Undoing the electrical connection  
c) Remove the mechanical securing elements  
d) Remove the force measuring sensor

 **WARNING!** If the force measuring sensor is to be reused, it must not be removed using impact tools!

### 3.5 Disposal

If the end of the service life is reached, the force measuring sensor is to be disposed of in an environmentally friendly way. Since the non-metallic components are a small proportion compared to the mass of the force measuring sensor, it can be recycled as a whole as scrap steel.

If the sensor is stored before final disposal, an appropriate storage location is to be selected which prevents harmful substances from entering the environment. If necessary, the sensor must be cleaned.

 **WARNING!** BROSA force measuring sensors contain traces of environmentally hazardous substances. This is also true of the impurities created during use. Contamination of the environment by these substances is to be prevented.