

Operating Manual

BROSA Angle Sensor Type 0804, 0813

English translation of German original operating manual

Version: 01/2024

Inhalt

1	General information	3
1.1	Safety instructions – Explanation of symbols:	3
2	Description of the BROSA angle sensor	4
2.1	Structure and functionality	4
2.2	Information on explosion protection.....	6
2.3	Indication of measuring direction	6
3	Advice on the safe handling of BROSA force measuring sensors.....	7
3.1	Handling	7
3.2	Installation and commissioning	7
3.2.1	General information	7
3.2.2	Additional information for operation in areas subject to explosion hazards ..	9
3.3	Operation and maintenance.....	9
3.3.1	Operation	9
3.3.2	Maintenance.....	10
3.4	Disassembly	11
3.5	Disposal.....	11

1 General information

Read the operating instructions and the product-specific documents carefully before commissioning the sensor.

Make sure that the sensor is fully suitable for the applications in question.

Improper use or any use other than intended may result in a malfunction of the sensor or undesirable effects in your application. For this reason, installation, electrical connection, commissioning and maintenance of the sensor may only be carried out by trained personnel authorized by the plant operator.

We also expressly point out that any liability is excluded if instructions in this documentation are disregarded.

The specified properties apply exclusively in the unchanged delivery condition. Applicable standards and guidelines must be observed, especially when recoating.

Current certificates can be downloaded from the BROSA GmbH website.

Only the German version of this operating manual represents the original document.

1.1 Safety instructions – Explanation of symbols:



WARNING! This symbol indicates dangers that can lead to personal injury and property damage!

2 Description of the BROSA angle sensor

2.1 Structure and functionality

The BROSA angle sensors of types 0804 and 0813 are used to measure an angle relative to the direction of gravity in or on machines of all types. This relationship is given by the definition of the measuring range in the form of defining the zero point and can be selected individually. Figure 1 shows the typical layout:

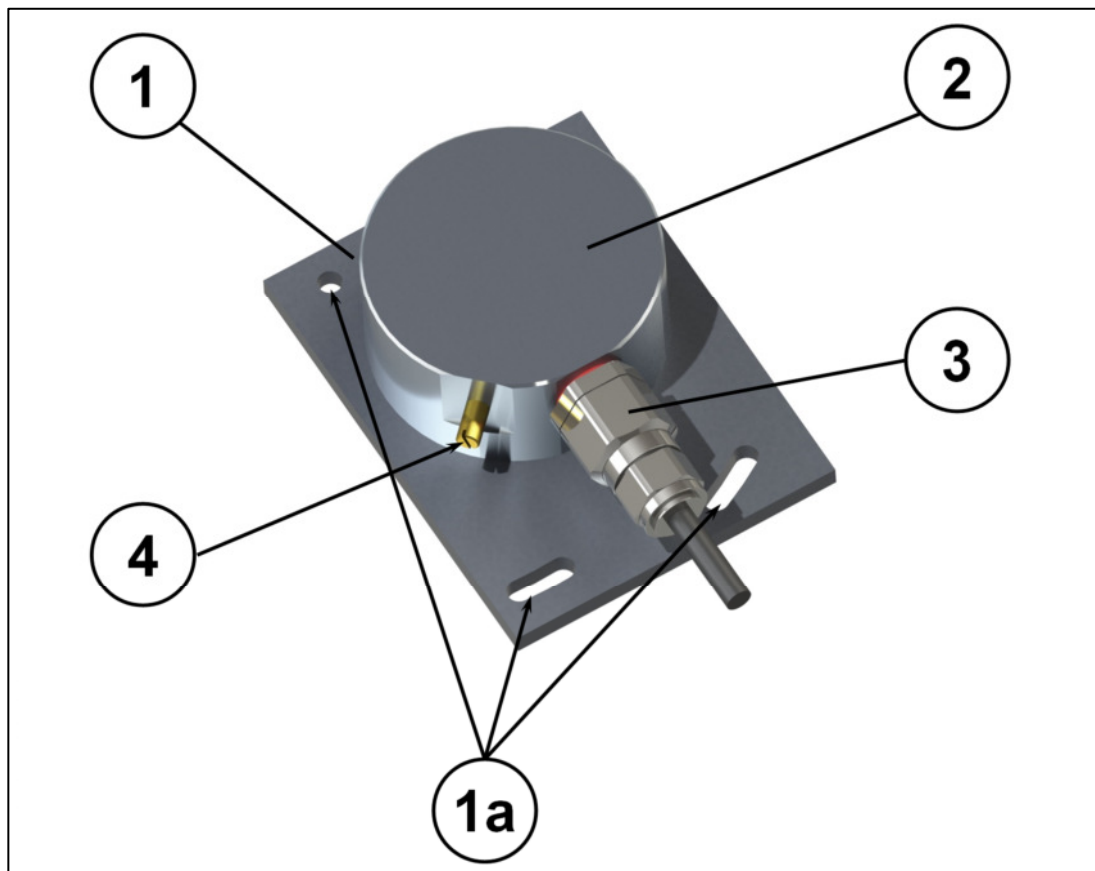

Fig. 1: Angle sensor

The angle sensor consists of a base plate (1) that has facilities (1a) for mounting at the installation site. It supports a housing (2) that contains the measurement electronics and has the elements necessary for the electrical connection (connector and cable, 3). The Ex d Type 0813 angle sensor is always equipped with a threaded pin (4) for electrical potential equalisation. Base plate and housing are made from an aluminium alloy as standard; stainless steel is available as an option.

Figure 2 shows the typical installation conditions:

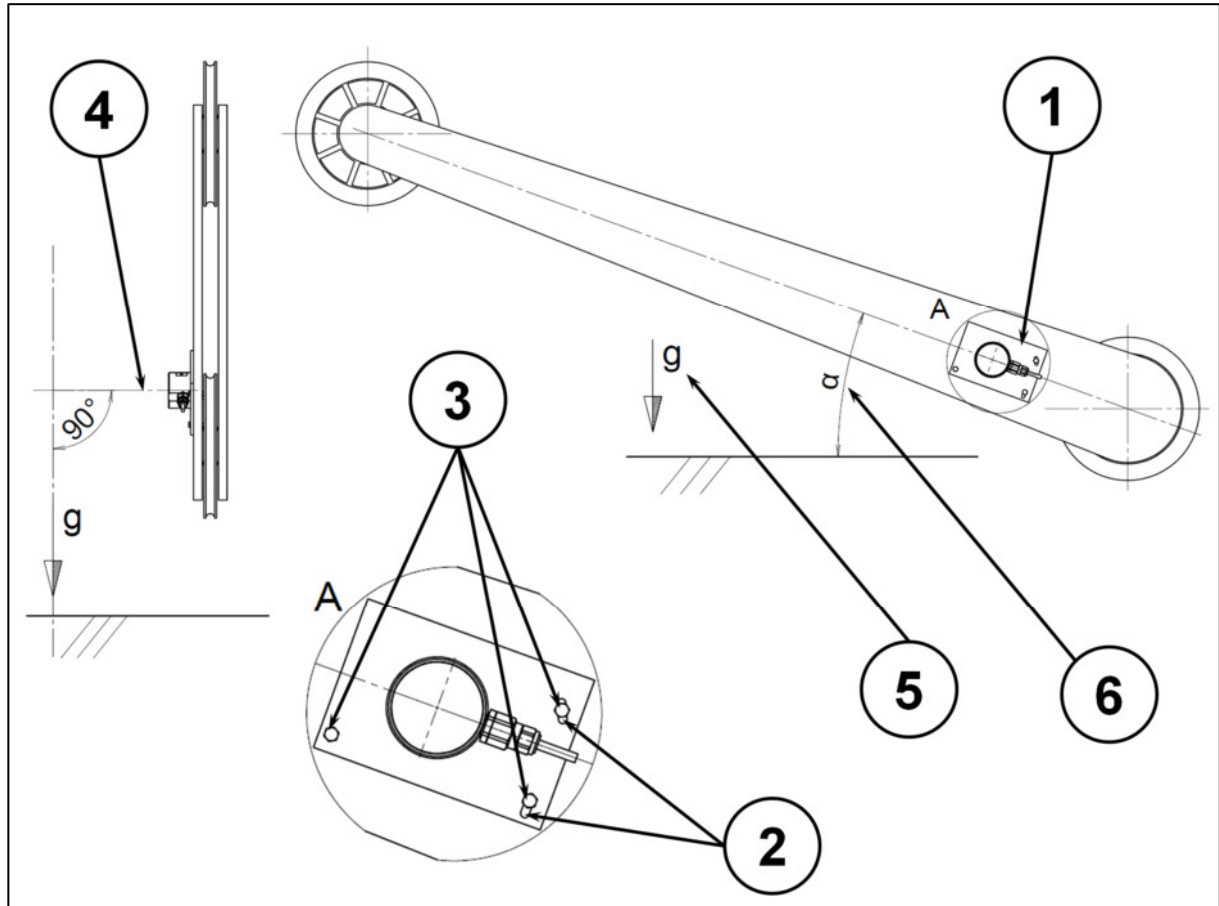

Figure 2: Installation conditions in an example for a crane boom

The angle sensor (1) is usually fixed at the installation site to the appropriately designed seatings (2) using securing elements (3). The normal to the measuring plane (4) is perpendicular to the direction of gravity (5). The measurement electronics measure the angular position (6) of the angle sensor in the measuring plane and output this as an electrical signal.

Versions with two measuring systems, either with output signals on separate connectors/cables or combined in one connector/cable, are available as options. More information can be found in the technical data sheets, which can be obtained free of charge from BROSA.

2.2 Information on explosion protection

The Ex d type 0813 angle sensor is designed to be pressure-resistant and is therefore suitable for use in potentially explosive atmospheres. Actual certificates can be downloaded on BROSA Homepage.



WARNING! Use of the Ex d angle sensor in zone 0 is not allowed. Current certificates can be downloaded from the BROSA GmbH website.

2.3 Indication of measuring direction

The alignment is shown on the upper side of the housing by an installation sketch (Figure 3, 2).

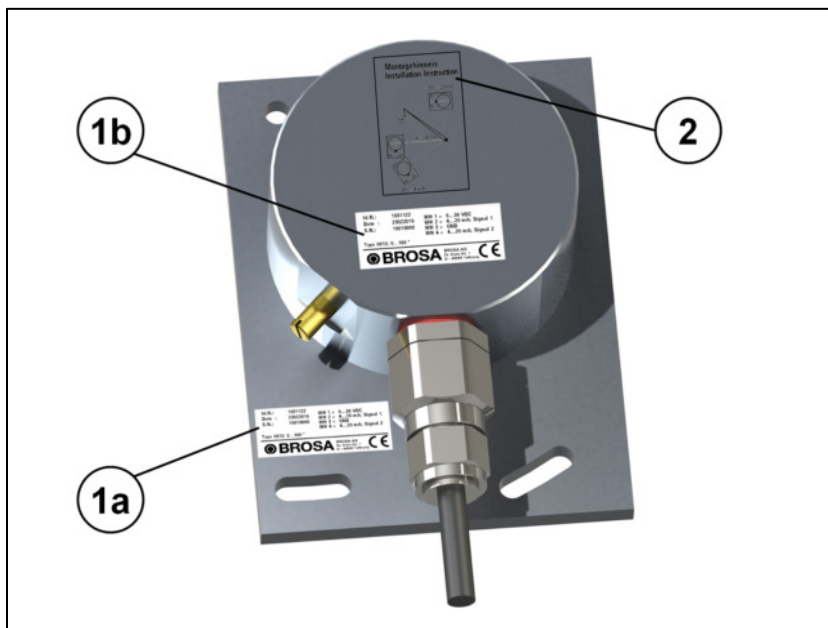

Figure 3: Measuring direction

3 Advice on the safe handling of BROSA angle sensors



WARNING! Non-compliance with the following instructions can lead to sensor damage and/or impairment of measurement results. The analysis of an erroneous measurement can result in personal injury or material damage.



WARNING! Despite their sturdy design, BROSA angle sensors may not be used for any other than the intended purpose (see. Section 1.1). With improper use, dangers to life and limb of the user or third parties and/or impairment of the device in which the angle sensor is implemented or other material assets can be caused.

3.1 Handling



WARNING! BROSA sensors contain high-quality measurement electronics. Make sure they are handled carefully.

- BROSA angle sensors are delivered in transport-safe packaging. We recommend that you remove the sensors from the package immediately prior to installation.
- BROSA angle sensors must be secured against falling. Do not throw sensors!
- Use as a tool (e.g., impact, slotting or lever tool) is not permitted; it can cause damage to the sensor and thus falsify the measurement results.

3.2 Installation and commissioning

3.2.1 General information

We recommend taking the following actions in the given order using the “four-eye principle”.

- a) Checking the sensor-measuring point assignment: It must be ensured that the sensor to be installed is designed for use at the intended measuring point. For this purpose, check information on the technical datasheet and the nameplate, in particular the item or the identification number and the measuring range, against the data of the measuring point.



WARNING! A sensor not designed for the particular measuring point must not be installed.

b) Inspection of the sensor for intactness and function: It must be ensured that the sensor to be incorporated is free of damage of any kind.



WARNING! A damaged sensor must not be installed!

c) Installation of the sensor into the measuring point: The angle sensor is to be attached to the device using the facilities available on the base plate (drilled holes, slots etc.) and appropriate securing elements.
After the attachment, the angle sensor is to be aligned in accordance with the label and then fixed in place. Attention must be paid to the correct alignment of the angle sensor.



WARNING! The force measuring sensor must not be driven in or aligned using impact tools!

After alignment, the angle sensor must be secured against movement and rotation using the elements provided for this purpose. Attention must be paid to the correct alignment of the angle sensor to the intended measuring direction (see direction marks).



WARNING! A misaligned sensor leads to erroneous measurement results!

d) Establishment of electrical connection: The elements on the sensor for the electrical connection are to be connected to the power supply, the earth connection if necessary, and the evaluation system of the device. In doing so, the information given on the nameplate for plug or cable assignment and, if applicable the installation guidelines of the cable, are to be observed.



WARNING! An incorrect or incomplete electrical connection impairs or prevents measurement.

e) Functional test: After the mechanical (see c) and electrical (see d) installations are completed, the sensor is to be moved over the entire designated measuring range; the output measurement signals are to be subjected to a plausibility check.

 **WARNING!** If due to unusual events (e.g., deformation or unusual noise), measurement results are considered implausible or there is suspicion that the sensor is malfunctioning for any other reason, it must not be put into operation.

3.2.2 Additional information for operation in areas subject to explosion hazards

 Only those sensors with the corresponding labels are approved for use in areas subject to explosion hazards.

If the open cable end is connected inside an area subject to explosion hazards, the connection must be inside a terminal box/switching cabinet certified in accordance with the ATEX-directive. If it is connected outside an area subject to explosion hazards, it must be in line with the general requirements for electrical equipment.

Close attention must be paid to the connection of the potential equalisation.

3.3 Operation and maintenance

3.3.1 Operation

BROSA angle sensors operate automatically; attaching tools is not required for operation. Direct manual intervention by the operator is not necessary; there are therefore no requirements for the operator to wear protective equipment during operation. However, the relevant requirements for the device in which the angle sensor is implemented must be observed.

BROSA angle sensors emit neither airborne acoustic noise nor electromagnetic radiation.

Operation of BROSA angle sensors is permitted only within the parameters and properties given in the technical datasheets and on the nameplate.

These are, among others:

- Measuring range
- Temperature range
- Permissible supply voltage
- Electrical protection class
- Material

Tilting away from the measuring plane leads to falsification of the measurement results and is therefore to be avoided.

Inductive or capacitive coupling with the connection cable(s) of the sensor can distort the measurement result and must be avoided. Some examples of these kinds of couplings can be caused e.g., by unfavourable cable routing (parallel power lines, frequency converters, transformers, motors, incorrect grounding/shielding and the like).

When performing electric welding in the vicinity of the sensor, all connections must be disconnected and isolated. It must be ensured that no welding current is flowing through the sensor.

 **WARNING!** Operation outside the specified parameters or contrary to existing properties or improper use can damage the sensor and cause it to fail or lead to faulty measuring results. If the sensor is overloaded, this can lead to the whole machine being equally overloaded and possibly endangering its stability.

3.3.2 Maintenance

In its capacity as a sensor, BROSA angle sensors are maintenance-free. Each angle sensor is to be inspected regularly for flawless condition as a preventive measure. The interval between inspections depends on the intensity of use and must be determined by the end user.

An inspection includes the following points:

- Visual inspection for damage to the measuring body and wiring as well as soiling
- Function test/plausibility check

The causes of existing errors are to be identified and remedied. If the test indicates an improper sensor state, it must be taken out of operation. If a malfunction or damage is detected on the sensor, it must be sent to the manufacturer's factory for diagnosis and, if necessary, repaired.

 **WARNING!** The sensor may only be repaired at the factory. Intervention (e.g., opening, mechanical processing or similar) done by parties other than the manufacturer means the safe operation of the sensor is no longer ensured and voids the warranty.

3.4 Disassembly

We recommend performing the following actions in the order given.

- a) Undoing the electrical connection
- b) Remove the mechanical securing elements
- c) Remove the angle sensor



WARNING! If the angle sensor is to be reused, it must not be removed using impact tools!

3.5 Disposal

If the end of the service life is reached, the angle sensor is to be disposed of in an environmentally friendly way. Since the non-metallic components are a small proportion compared to the mass of the force measuring sensor, it can be recycled as a whole as aluminium or scrap steel.

If the sensor is stored before final disposal, an appropriate storage location is to be selected which prevents harmful substances from entering the environment. If necessary, the sensor must be cleaned.



WARNING! BROSA angle sensors contain traces of environmentally hazardous substances. This is also true of the impurities created during use. Contamination of the environment by these substances is to be prevented.